

Clamping pads

adjustable

SPECIFICATION

Types

- Type **B**: Smooth contact face
- Type **R**: Serrated contact face
- Type **BR**: Smooth contact face, with automatic return
- Type **RR**: Serrated contact face, with automatic return

Steel
tempered, phosphated

Ball
Steel
hardened, blank

Spring element
Plastic (PUR)
(Type BR / RR)

Hexagon nut ISO 4035 (DIN 439)
Steel
blackened



INFORMATION

GN 709.3 clamping pads are used as movable supports or plungers for clamping workpieces. They can also be used as stops.

After the clamping process, the contact surfaces of clamping pads automatically reset themselves to their initial position. This prevents the bearing from jamming in an inclined position when the workpiece is inserted.

The bearing can be rotated by a maximum of 9° and is secured against further rotation.

TECHNICAL INFORMATION

- Elastomer characteristics (see page A32)

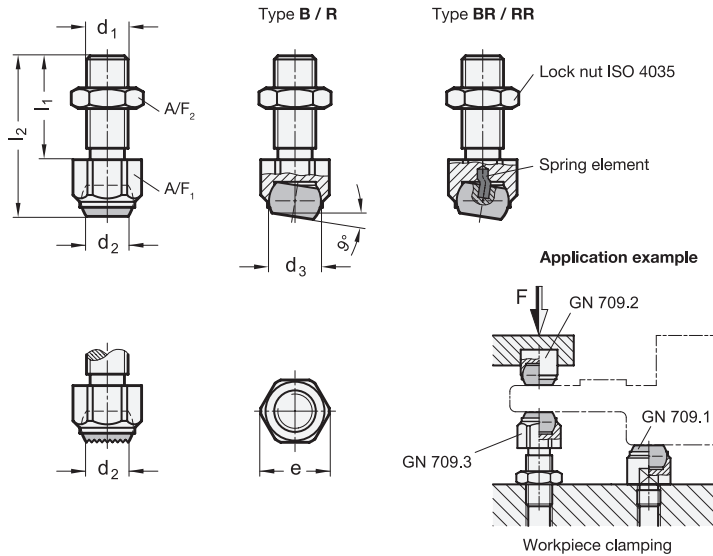





GN 709.3-B

Description	A/F 1	d1	d2	d3	e	l1	l2	A/F 2	Static load max. in kN	
GN 709.3-13-M8-B	13	M 8	5.8	8.5	14.5	25	36.6	13	8	20
GN 709.3-17-M10-B	17	M 10	8.6	12	19	30	45.7	17	8	44
GN 709.3-17-M12-B	17	M 12	8.6	12	19	35	50.7	19	15	56
GN 709.3-24-M16-B	24	M 16	10.5	16	27	40	60.7	24	25	128
GN 709.3-30-M20-B	30	M 20	20	25	33	50	77.3	30	90	275
GN 709.3-36-M24-B	36	M 24	20	25	40	70	100	36	90	472
GN 709.3-46-M30x1.5-B	46	M 30 x 1.5	34.6	40	51	65	100	46	165	772

GN 709.3-R

Description	A/F 1	d1	d2	d3	e	l1	l2	A/F 2	Static load max. in kN	
GN 709.3-13-M8-R	13	M 8	5.8	8.5	14.5	25	36.6	13	8	20
GN 709.3-17-M10-R	17	M 10	8.6	12	19	30	45.7	17	8	44
GN 709.3-17-M12-R	17	M 12	8.6	12	19	35	50.7	19	15	56
GN 709.3-24-M16-R	24	M 16	10.5	16	27	40	60.7	24	25	128
GN 709.3-30-M20-R	30	M 20	20	25	33	50	77.3	30	90	274
GN 709.3-36-M24-R	36	M 24	20	25	40	70	100	36	90	435
GN 709.3-46-M30x1.5-R	46	M 30 x 1.5	34.6	40	51	65	100	46	165	772

GN 709.3-BR

Description	A/F 1	d1	d2	d3	e	l1	l2	A/F 2	Static load max. in kN	
GN 709.3-13-M8-BR	13	M 8	5.8	8.5	14.5	25	36.6	13	8	19
GN 709.3-17-M10-BR	17	M 10	8.6	12	19	30	45.7	17	8	43
GN 709.3-17-M12-BR	17	M 12	8.6	12	19	35	50.7	19	15	55
GN 709.3-24-M16-BR	24	M 16	10.5	16	27	40	60.7	24	25	124
GN 709.3-30-M20-BR	30	M 20	20	25	33	50	77.3	30	90	267
GN 709.3-36-M24-BR	36	M 24	20	25	40	70	100	36	90	457
GN 709.3-46-M30x1.5-BR	46	M 30 x 1.5	34.6	40	51	65	100	46	165	797

GN 709.3-RR

Description	A/F 1	d1	d2	d3	e	l1	l2	A/F 2	Static load max. in kN	
GN 709.3-13-M8-RR	13	M 8	5.8	8.5	14.5	25	36.6	13	8	19
GN 709.3-17-M10-RR	17	M 10	8.6	12	19	30	45.7	17	8	43
GN 709.3-17-M12-RR	17	M 12	8.6	12	19	35	50.7	19	15	55
GN 709.3-24-M16-RR	24	M 16	10.5	16	27	40	60.7	24	25	124
GN 709.3-30-M20-RR	30	M 20	20	25	33	50	77.3	30	90	267
GN 709.3-36-M24-RR	36	M 24	20	25	40	70	100	36	90	457
GN 709.3-46-M30x1.5-RR	46	M 30 x 1.5	34.6	40	51	65	100	46	165	797